

900 Control Station Specifications

51-52-03-46 April 2009



Introduction

The 900 Control Station operator interface from Honeywell compliments the HC900 Hybrid Controller with a unique combination of predefined display features and custom display development tools to deliver ease of use and high flexibility in an efficient and affordable package. The 10.4 inch color display and finger touch user interface enhances process monitoring while simplifying online controller changes. The Station Designer software used to configure the interface works in conjunction with the HC900 Hybrid Controller configuration software to automatically build a Control Station database that exactly matches the unique, user configured, controller database. This highly integrated operation eliminates the time consuming task of assigning controller communication register addresses to the operator interface parameters used to build displays. The standard database of the Control Station allows all available controller tags to be imported without restriction or costly price adders, eliminating the risk of running out of tag resources in the middle of your project.

The hardware of the 900 Control Station is designed to handle tough industrial environments with a full metal case design and water tight, type 4X, front bezel assembly. Hardware pushbuttons on the front panel supplement touch screen software buttons for common interface tasks such as user log-off, display last screen and main menu access. A Home button is also provided to allow the user to specify a common starting point for his application. LED indicators provide power status, indication of flash memory access and active alarm status.

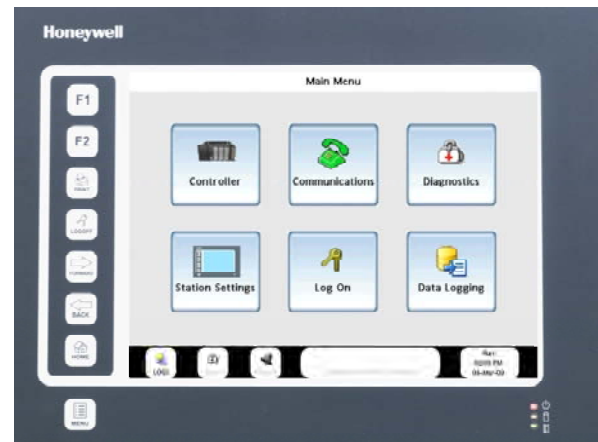

900 Control Station

Connecting the 900 Control Station to the controller can be via Ethernet using CAT 5 cable and RJ45 connectors or via RS485 serial communications. Ethernet is recommended for new installations while RS485 connections may be used with pre-existing HC900 controller installations. Two USB host ports and one USB device port are also provided to extend data export functions and to support configuration upload/download and maintenance functions. A Flash memory socket is provided so that a Flash card can be used to collect your trending and data logging information, accept screen print files, as well as to store larger configuration files.

Models		
Model number	900CS10-xx	Control Station
Model number	900SDS-xx-xx-xx	Station Designer Software
xx = revision numbers		

Highlights







- Hardened industrial platform may be mounted close to the process for greater operator efficiency.
- Resistive analog touch screen allows simplified operation
- Dedicated keypad buttons for frequently accessed functions
- 10.4 inch, 16K color VGA (640x480 pixel) LCD display for bright, clear screen presentations
- Three front panel LED status indicators confirm operation
- Expandable memory with Flash Memory socket for record keeping and configuration transfer
- Configuration stored in non-volatile memory for secure operation
- 10 Base T/100 Base-TX Ethernet communications for optimum performance
- RS485 communications allows updating existing HC900 installations
- Station Designer configuration software automatically builds communication paths and completes parameter identifications
- Web access to view and manage your process from anywhere
- Large assortment of prebuilt displays and display widgets saves configuration time
- Fully manage HC900 controller function blocks such as PID, setpoint programmers, etc.
- Prebuilt recipe management functions
- Create custom displays using the graphic editing tools of Station Designer software
- Build custom displays using a large assortment of prebuilt industrial graphic objects (valves, tanks, vessels etc.)
- Extend interface functions with robust scripting functions (if-then-else)
- Prebuilt display navigation features and pre-assigned function buttons to get on-line quickly
- Improve status monitoring and system troubleshooting with more than 70 standard controller screens - (no setup required)

- Maintain records of process performance with flexible data logging and trending
- Math and Scripting for your more demanding applications

Master Template and Buttons

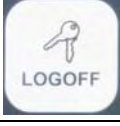
The 900 Control Station uses membrane buttons to access common operator functions and a status tray at the bottom of the screen to indicate system operating status. The combination of display buttons and screen status buttons create a master template that serves as the default navigation structure and basic framework for all operator displays. The status indicators of the screen also provide button access to summary displays for additional detail.

Membrane buttons (left of display)

	User-specified action
	User-specified action
	Print Screen
	Security Log ON/OFF
	Next Screen
	Previous Screen
	Home (user specified home display)
	Main menu

Display buttons (bottom of screen)

	Time and date, controller mode
	Data logging, data export function access
	Diagnostic indication, diagnostic status access
	Active alarm indication, alarm summary access
	Event messages, alarm and event summary access

Controller Displays

Controller status displays are a standard feature of the 900 Control Station and may be used to verify controller setup parameters and/or troubleshoot controller diagnostics.

Accessed via the main menu key, these displays require no pre-configuration and become available when a database is downloaded and an operator interface is connected to a controller. Examples of status displays include controller Ethernet port setup, local and expansion rack diagnostics, host communications connections, peer connections, redundant system status, Modbus slave status and others.

Operate Displays

Displays used by the operator are developed by selecting from a predefined list of displays, creating custom displays with function block widgets (predefined graphic objects designed to interface with HC900 function blocks) or ground up custom development using a combination of drawing tools, predefined graphic objects, imported graphic objects, action and navigation buttons. The quantity of displays supported is not artificially limited. Typical uses can have 50 or more user defined displays, depending on complexity.

Alarm/Events

Alarms and Events in the 900 Control Station are an integral part of the setup of analog and digital signal tags in the interface. Two alarms or events per signal tag are standard and additional levels may be added when needed. Automatic or manual acknowledgement, delay action, and emailing of alarm status are standard user selections. Alarm detections may be on a high value condition, low value condition, deviation above or below a setpoint, value within a band, value equal to a setpoint, value not equal a setpoint, raising value, falling value or changing value.

Active alarm notification is provided with an indicator button that is present on all user displays. Pressing the button allows viewing alarm detail, including time of occurrence, and allow for user acknowledgement when the option is enabled. A selectable pulsing display action is also available to call an operator's attention to a high priority alarm condition.

Assigning event action to digital signals causes the event description data to be annunciated in the display tray of the interface. This feature allows for prompting operators to perform specific tasks when action is needed.

An Alarm and Event Summary display is provided to indicate the time and sequence in which alarms and events occurred, when they were acknowledged and when the alarm condition cleared. The active event message may also be cleared from the display tray from this display.

Alarm and Event Summary			
■	10:14:58	15/04/2009	Accept Vacuum Furnace High Alarm
	10:14:52	15/04/2009	Accept Vacuum Furnace Hi Hi Alarm
	10:07:55	15/04/2009	Alarm Vacuum Furnace Hi Hi Alarm
	10:07:48	15/04/2009	Alarm Vacuum Furnace High Alarm
	14:15:05	14/04/2009	Event End of Cycle - Unload Furnace - Turn Off Pow
■	13:57:48	14/04/2009	Event End of Cycle - Unload Furnace - Turn Off Pow

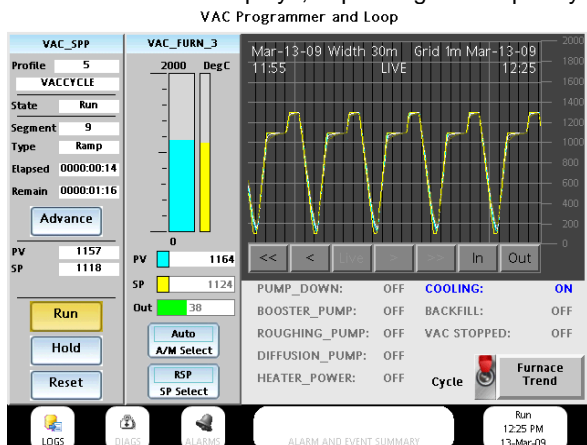

Standard Displays

Standard displays are provided to allow the 900 Control Station to read and present HC900 controller setup parameters, monitor controller performance, view communications status of the various controller communication ports, perform I/O calibrations, diagnose problems and more. See the following examples.

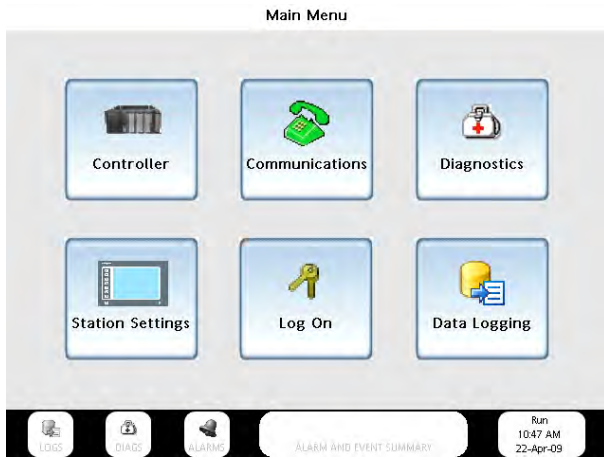

Example of Standard display

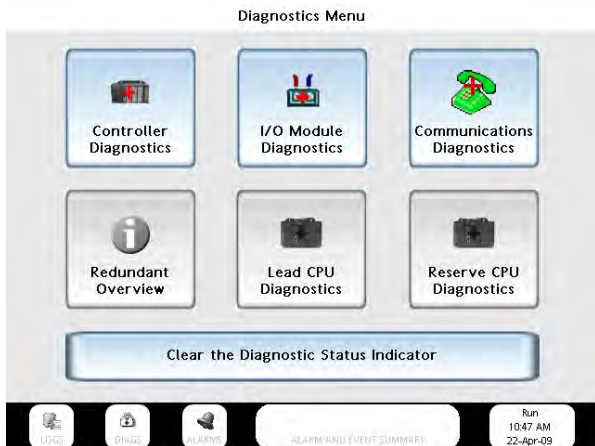

Example of Standard display

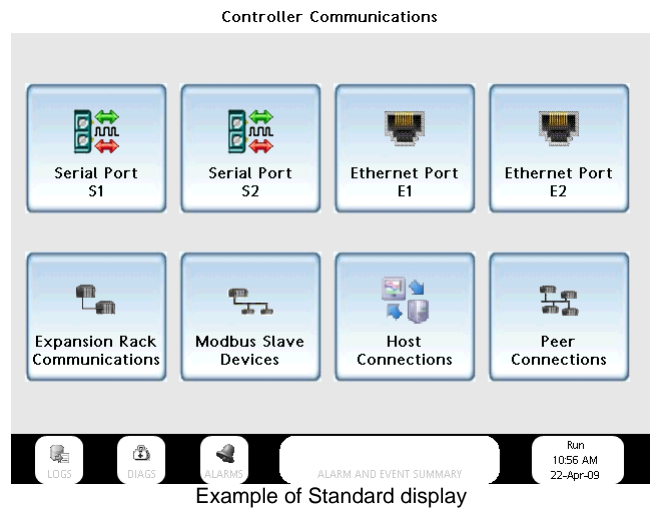

Example of Standard display

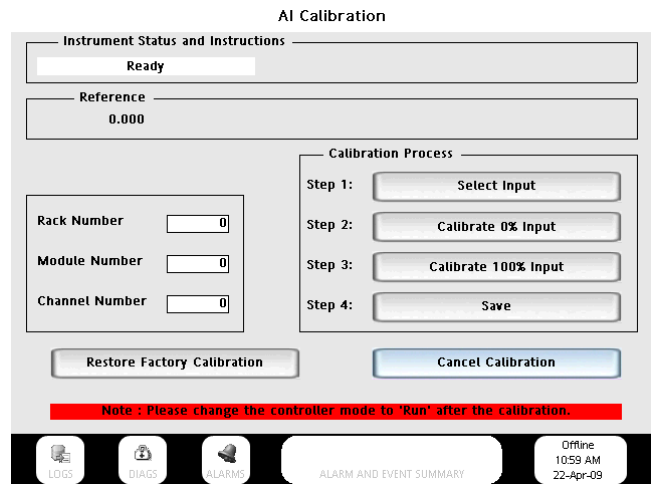

Example of Standard display

In addition to detailed controller displays, a number of graphic display templates, interactive function block graphic widgets and predefined navigation buttons and tools are provided to accelerate interface setup and configuration. See the following examples.

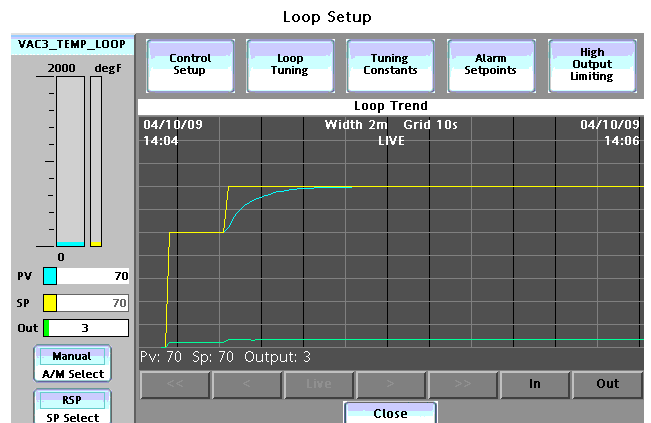

Example of Loop tuning trend

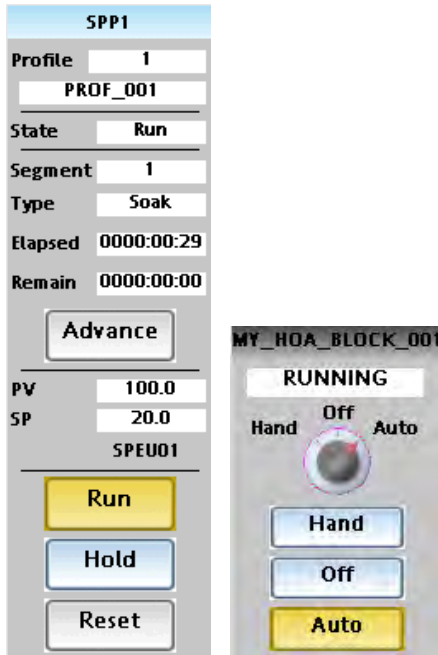

Example of Setpoint Programmer and HOA Block widgets

The 900 Station Designer Software makes available more than 70 standard displays for controller operation, status and maintenance, including display widgets to allow users to quickly build semi-custom displays for interaction with the controller's principle function blocks. Recipe selection of setpoint profiles, setpoint schedules, sequences and variables stored in the controller is also supported.

Custom displays

In addition to standard displays, the 900 Control Station supports a full array of custom graphic displays that may be created using objects drawn with basic drawing tools, an assortment of object primitives, pre-defined widgets matching controller functions, graphic symbols selected from an extensive assortment of objects in the standard image library and/or imported JPEG, bitmap or WMF files. Visibility controls allow the user to hide or make objects visible as determined by the state or value of a parameter in the controller or station.

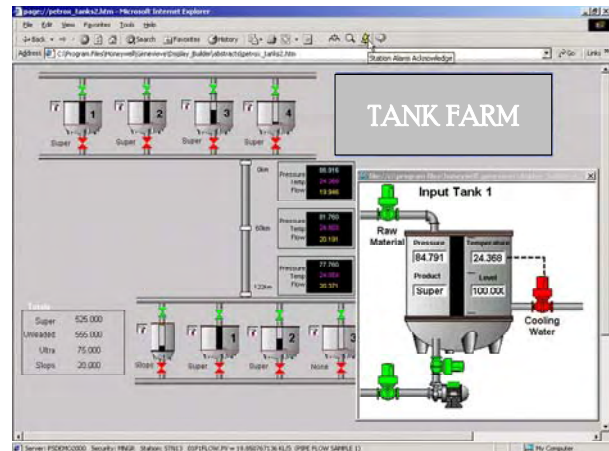

Example of custom display

Symbol Library

The 900 Station Designer Software contains over 4000 industrial graphic objects in over 60 different categories to provide realistic graphic images for your application. Detailed images of various types of pumps, valves, tanks may be overlaid one on top of another and have actions assigned. Animation is supported with objects moving within a specified display field. Graphic images of Motors, blowers, pumps and other process equipment make creating accurate process views a fast and easy operation. Images support color selection, may be sized, oriented on the display and inserted in a predefined animation area having multiple positions linked to values in the database.

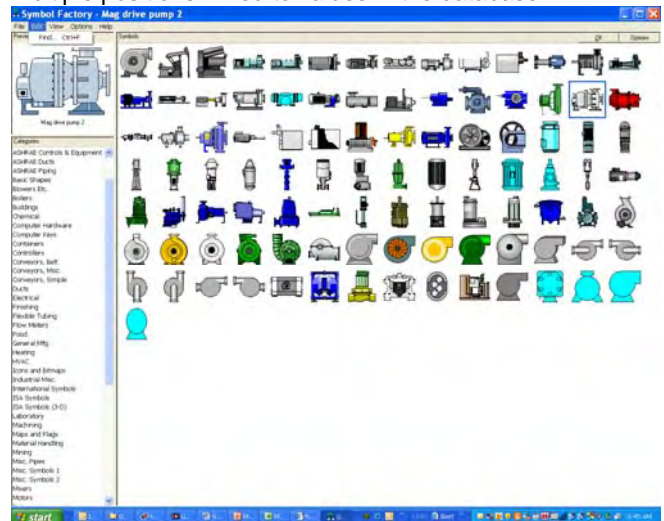

Symbol library

Recipes

The 900 Control Station provides standard displays to allow operators to select from the recipes stored in the internal memory of the HC900 controller for fast and easy product changeover. Recipes may be a list of 50 variables (Variable Recipe), a setpoint profile used with the setpoint

programmer function block, setpoint schedules, or sequences used with the Sequencer function block. Recipes of the specific type are selected from a list, by name, from a list read from the controller. Recipes are created using Hybrid Control Designer Software or Hybrid Control Utilities Software and are stored in the HC900 controller. Recipes added to the HC900 controller after the database import operation during operator interface configuration will also be accessible from the Control Station recipe list.

Data Logging

The 900 Control Station will log tagged data at user-specified rates and automatically apply a time/date stamp. The information is stored in CSV (Comma-Separated Variable) file format, allowing easy access from almost any PC application program, such as Microsoft Excel®. Data logs may be stored in volatile RAM memory for short term, non-critical data viewing or they may be stored on more secure archiving media such as Flash memory module or USB memory modules. The number of concurrent log files supported is dependent on the available storage memory, data sample rates and file size allocations.

Data logging is stored to a Flash memory module in the industry standard CSV format. The number of data logs in the Station and the number of controller tags in a Log file are not limited. Before data is sent to the Flash module, it is held in a History Buffer in RAM memory where it may be viewed as short term history using a Trend Viewer object.

The validity of stored data may be secured by the addition of cryptographic signatures on the samples of stored data. The signature is a unique 32 bit value that is included with the data samples, adding one more parameter to the log record. The signature value is derived using an algorithm that uniquely identifies the values within a dataset, similar to a checksum on a software program. Changing any value within the dataset causes a signature mismatch between the data and the signature. A utility application is provided with Station Designer software to allow users to validate if a CSV file has been altered or not. Any value that is changed will invalidate all records in the file following the changed value.

1	➔	😊	Date,Time,Pv,Sp,TC1,TC2,TC3,Signature
2		😊	2009/03/23,19:00:00,965,985,949,930,912
3		😊	2009/03/23,19:00:06,1006,1026,989,970,952
4		😊	2009/03/23,19:00:12,1046,1066,1030,1011,992
5		😊	2009/03/23,19:00:18,1087,1107,1070,1051,1032
6		😊	2009/03/23,19:00:24,1127,1147,1111,1091,1072
7		😊	2009/03/23,19:00:30,1164,1184,1148,1128,1109
8		😊	2009/03/23,19:00:36,1195,1200,1177,1158,1140

Data Validated via Signatures

1		😊	Date,Time,Pv,Sp,TC1,TC2,TC3,Signature
2		😊	2009/03/23,19:00:00,965,985,949,930,912
3	➔	😞	2009/03/23,19:00:06,1006,1026,989,970,952
4		😞	2009/03/23,19:00:12,1046,1066,1030,1011,992
5		😞	2009/03/23,19:00:18,1087,1107,1070,1051,1032
6		😞	2009/03/23,19:00:24,1127,1147,1111,1091,1072

Altered Data Detected via Signatures

There are 5 methods available to access data stored on the Flash memory module.

1. Transfer data from Flash memory to a removable USB memory module.
2. Use the FTP server to allow remote clients to connect to the station and upload the log files.
3. Use a Synchronization Manager to push log files to an FTP server on a periodic basis.
4. Use a Web server to access Log files over the station's Ethernet port using a Web browser such as Microsoft Internet Explorer.
5. Mount the flash memory module as a drive on a PC and allow logs to be copied via Windows® Explorer.

Web Access

The 900 Control Station supports Web access to data and displays from remote locations.

CS Web Server	
Option	Description
View Data	Display a list showing available data pages.
View Batch Logs	Download batch files from the data logger.
View Continuous Logs	Download continuous files from the data logger.
Remote View	Display a view of the HMI's display and keyboard.

- The *Data Log Access* property is used to enable or disable Web access to the files created by the Data Logger.

- The *Remote Viewing* property is used to enable or disable a facility by which a Web browser can be used to view the current contents of a Control Station display.
- The *Remote Control* property is used to enable or disable an option by which the remote viewing facility is extended to allow a Web browser to be used to simulate the pressing of keys on the operator panel, thereby allowing remote control of the panel or the HC900 Controller it controls.
- The *Custom Site* property is used to enable or disable a facility by which files stored in the WEB directory of the Flash memory card are exposed via the Web server.
- The *Security* properties are used to restrict Web server access to hosts whose IP address matches the mask and data indicated.
- The *Authentication* properties are used to restrict access to any user connecting onto the Web server when Authenticated Users is selected. Upon connection, the user will be required to enter the Username and Password defined under Logon Username (Max 31 characters) and Logon Password (Max 15 characters). Both are case sensitive.

You may thus use the Control Station's custom site facility to create a completely custom Web site using your favorite third-party HTML editor, and—by inserting certain sequences and storing the resulting files on the station's flash memory card—expose this site using the station's Web server.

Email Notification

Alarms that are configured in the station may be configured to send an email notification to specified addresses when the alarm is present. Event messaging is also supported to announce other events in the system. You can choose to email alarm messages to one person or to several people simultaneously. The Email server provides support for a device name to identify the source of email data and a name used for SMTP Authentication.

FTP Server

The 900 Control Station's FTP server provides a method to exchange files between the station and a remote computer running an FTP client application. The station will act as a server, waiting for the client application to connect and upload or download files.

The FTP Server may be set to Disabled (restricting all remote access), Enabled for anonymous Read-only access, or anonymous read and write access.

Typical types of files exchanged via FTP include data log files of process performance history and print screen files generated using the print screen key of the station.

A log file is also available to track remote interactions via FTP with the flash memory module of the station, useful in debugging FTP operations.

Security

Station Designer contains powerful features that allow you to define which operators have access to which display pages, and limit those operators ability to make changes to specific data using a user profile with password protected access and object based controls. The number of user profiles permitted is not limited.

When enabled by Station Designer, the station also provides a security logging facility that can be used to record changes to data values, indicating when the change occurred and by whom it was performed.

Web access security is also provided to limit remote user's access to control and edit functions and/or all remote access.

Math & Formulas

Values within the 900 Control Station may be the result of mathematical expressions created during configuration with Station Designer. Expressions may be performed using signal tag data and constants in Decimal, Binary, Octal or Hexadecimal format and operations performed using integer or floating point math.

Expressions may also include comparisons (comparing one value to another) with operator (<, >, =, etc.) to generate a 0 (false) or 1 (true) output value.

Programs

When actions become too complex to fit on a single line of an expression, or they demand more complex decision

making logic, Station Designer provides a facility to create and manipulate user developed programs. If, then, else decision statements, switch statements, loop and while loop constructs, do loop statements and other instructions are available for users to develop their own custom programs. User programs may be set to run when referenced or be scheduled to run in the background.

Database Import

HC900 Controller configuration files created with HC900 Hybrid Control Designer software may be imported into Station Designer to automatically construct a station database that exactly matches the controller's configuration.

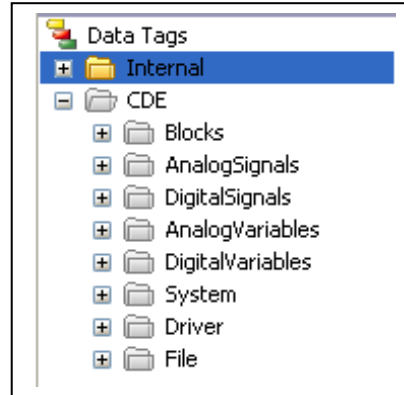

A database mismatch between the controller's database and the station's database is automatically detected when the station is communicating with the controller, eliminating any possibility of erroneous data exchanges.

Specifications	
Power	+24 VDC \pm 20% @ 29 W maximum. Requires Class 2 or SELV rated power supply Front panel LED indication of power on
Power Connections	Connection via removable three position terminal block Compression cage-clamp terminal block. Wire Gage: 12-30 AWG copper wire Torque: 5-7 inch-pounds (56-79 N-cm)
LCD Display	Size: 10.4-Inch Type: Color active matrix thin film transistor (TFT) Colors: 16,000 Pixels: 640 X 480 Backlight* 50,000 Hr life typical (field replaceable in non-hazardous locations) *Lifetime at room temperature
Touch screen and Keypad	Analog resistive Protective layer - Optional protective layer over touch panel Keypad: 8 button keypad on front, six (6) dedicated and two (2) user defined keys
Memory	On Board User Memory: 32 Mbyte non-volatile Flash memory. Optional Memory Card: CompactFlash Type II slot for Type I and Type II CompactFlash cards (behind panel) Note: The flash memory card must be a UL approved component to maintain UL station approval when installed. Front panel LED indication of activity
Battery	Lithium coin cell, UL recognized type CR2025. Typical lifetime of 10 years.
Clock	Real Time Clock: Yes Supports alarms, events, displays, trends, and data logging Synchronization to controller: within 1 second

Specifications	
Ports and Communications	<p>USB Ports:</p> <ul style="list-style-type: none"> One (1) Type B Device Port Two (2) Type A host ports Adhere to USB specification 2.0. <p>RS232 Serial Ports: (RJ12 connectors)</p> <ul style="list-style-type: none"> One (1) Communication port One (1) Programming/Communication Port Format and Baud Rates individually software programmable up to 115,200 baud Max. Distance: 50 ft. Protocol: Modbus Master <p>RS485 Comm. Port (RJ45 connector)</p> <ul style="list-style-type: none"> Max. Distance: 2000 ft max. Protocols: HC900, Modbus Master <p>Ethernet Port: (RJ45 connector) -wired as a NIC (Network Interface Card)</p> <ul style="list-style-type: none"> 10 BASE-T / 100 BASE-TX Max. Distance 100M Protocols: HC900, Modbus TCP
Environmental	<p>Operating Temperature Range: 0 to 50 °C (32 to 122 F)</p> <p>Storage Temperature Range: -20 to 70 °C (-4 to 158 °F)</p> <p>Operating and Storage Humidity: 80% maximum relative humidity (non-condensing) from 0 to 50°C.</p> <p>Vibration According to IEC 68-2-6: 5 to 150 Hz, in X, Y, Z direction for 1.5 hours, 2 g.</p> <p>Shock According to IEC 68-2-27: Operational 35 g, 9 msec in 3 directions.</p> <p>Altitude: Up to 2000 meters.</p>
Safety	<p>EN 61010-1 – 2001. CE Mark requirements for General Purpose (Ordinary Location) Safety.</p> <p>ANSI/UL 61010-1 – 2004, Second Edition. General Purpose (Ordinary Location) Safety.</p> <p>CSA C22.2 No. 1010-1-2004- Second Edition. General Purpose (Ordinary Location) Safety.</p> <p>Type 4X Indoor use only Enclosure rating (face only), UL50.</p> <p>IP66 Enclosure rating (face only), IEC529.</p> <p>IEC61326 - 2005 CE Mark EMC requirements for electrical equipment for measurement, control and laboratory use.</p>

Specifications																								
Electromagnetic Compatibility	Immunity to Industrial Locations: <table border="0" style="width: 100%;"> <tr> <td style="width: 30%;">ESD</td> <td style="width: 20%;">IEC 61000-4-2</td> <td style="width: 50%;">Criterion A 4kV contact discharge 8kV air discharge</td> </tr> <tr> <td>EM field</td> <td>IEC 61000-4-3</td> <td>Criterion A 10 V/m</td> </tr> <tr> <td>Electrical Fast Transient/Burst</td> <td>IEC 61000-4-4</td> <td>Criterion A 2kV power 2kV I/O signal/control, including functional earth lines</td> </tr> <tr> <td>Surge</td> <td>IEC 61000-4-5</td> <td>Criterion B 1kV L-L, 2kV L-Gnd power 1kV I/O signal/control, including functional earth lines</td> </tr> <tr> <td>Conducted RF</td> <td>IEC 61000-4-6</td> <td>Criterion A 3Vrms Power and all I/O</td> </tr> <tr> <td>Magnetic field</td> <td>IEC 61000-4-8</td> <td>Criterion A 30A/m</td> </tr> </table> Emissions: <table border="0" style="width: 100%;"> <tr> <td style="width: 30%;">Emissions</td> <td style="width: 20%;">EN 55011 (CISPR11)</td> <td style="width: 50%;">Class A</td> </tr> </table>			ESD	IEC 61000-4-2	Criterion A 4kV contact discharge 8kV air discharge	EM field	IEC 61000-4-3	Criterion A 10 V/m	Electrical Fast Transient/Burst	IEC 61000-4-4	Criterion A 2kV power 2kV I/O signal/control, including functional earth lines	Surge	IEC 61000-4-5	Criterion B 1kV L-L, 2kV L-Gnd power 1kV I/O signal/control, including functional earth lines	Conducted RF	IEC 61000-4-6	Criterion A 3Vrms Power and all I/O	Magnetic field	IEC 61000-4-8	Criterion A 30A/m	Emissions	EN 55011 (CISPR11)	Class A
ESD	IEC 61000-4-2	Criterion A 4kV contact discharge 8kV air discharge																						
EM field	IEC 61000-4-3	Criterion A 10 V/m																						
Electrical Fast Transient/Burst	IEC 61000-4-4	Criterion A 2kV power 2kV I/O signal/control, including functional earth lines																						
Surge	IEC 61000-4-5	Criterion B 1kV L-L, 2kV L-Gnd power 1kV I/O signal/control, including functional earth lines																						
Conducted RF	IEC 61000-4-6	Criterion A 3Vrms Power and all I/O																						
Magnetic field	IEC 61000-4-8	Criterion A 30A/m																						
Emissions	EN 55011 (CISPR11)	Class A																						
Construction	Steel rear metal enclosure with NEMA 4X/IP66 aluminum front plate when correctly fitted with the gasket provided. Installation Category II, Pollution Degree 2.																							
Mounting	Panel Mount with gasket using 14 #8-32 studs Maximum panel thickness: 0.25" (6.3 mm). For NEMA 4X/IP66 sealing, a steel panel with minimum thickness of 0.125" (3.17 mm) is recommended. Maximum Mounting Stud Torque: 17 inch-pounds (1.92 N-m) Depth behind panel: 2.35 inches (59.6 mm) Front bezel Thickness: 0.2 inches (5.08mm)																							
Weight	5.7 lbs (2.59 Kg)																							
Functions																								
Security	Log-on and log-off via user name and password Remote Web interface and local log-on via user name and password Up to 50 users Different groups of users and permissions Audit trail records																							

Specifications	
Display Capabilities	<p>Graphic objects:</p> <ul style="list-style-type: none"> Industrial automation graphic objects (tanks, pipes, pumps) Industrial gadgets (buttons, switches, lamps) Navigation buttons Drawing objects (circles, lines, etc) Importing of images (bmp, tif, jpg) Dictionary text objects Widgets (Predefined for controller function blocks) <p>Animation:</p> <ul style="list-style-type: none"> Visible / not visible, flashing, background color change, foreground color change <p>Display capacity:</p> <ul style="list-style-type: none"> Number of screens limited by available memory >50 typical <p>Master Display:</p> <ul style="list-style-type: none"> Sets common attributes for all displays <p>Data entry:</p> <ul style="list-style-type: none"> Numeric entry including decimal point Time and date entry Audible feedback on data entry / touch <p>Scripting:</p> <ul style="list-style-type: none"> If-then-else statements Multiple levels (trigger display actions and parameter writes)
Data Logging	<p>Media: Volatile RAM memory, optional non-volatile flash card memory or removable USB memory module</p> <p>Data Types: Process history, alarms, events, diagnostics, user changes</p> <p>Export format: CSV</p>
Configuration Software	<p>Station Designer:</p> <ul style="list-style-type: none"> WYSIWYG (what-you-see-is-what-you-get) displays from PC to operator interface Software tag limits not imposed Import utility for Hybrid Control Designer .cde files to Station Designer .sds files for database transfer Windows 2000, XP, Vista support

Dimensions

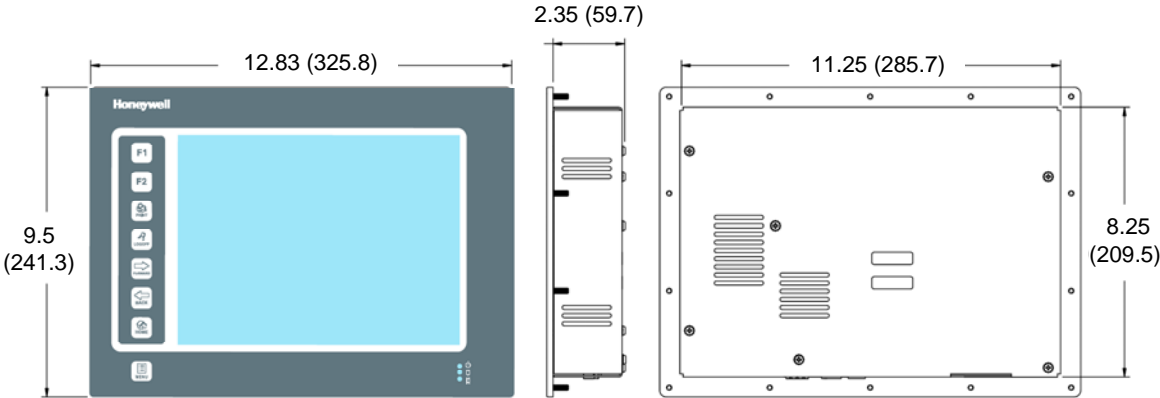

Ordering information

Contact your nearest Honeywell sales office, or

In the U.S.:
Honeywell
Field Solutions
2500 West Union Hills.
Phoenix, AZ 85027

In Canada:
The Honeywell Centre
85 Enterprise Blvd., Suite 100
Markham, ONT. L6G 0B5

In Latin America:
Honeywell
1250 West Sam Houston Parkway South
Houston, TX 77042

In Europe and Africa:
Honeywell S. A.
Avenue du Bourget 1
1140 Brussels, Belgium

In Eastern Europe:
Honeywell Praha,
s.r.o. Budejovicka 1
140 21 Prague 4,
Czech Republic

In the Middle East:
Honeywell Middle East Ltd.
Khalifa Street,
Sheikh Faisal Building
Abu Dhabi, U. A. E.

In Asia:
Honeywell Asia Pacific Inc.
Honeywell Building,
17 Changi Business Park Central 1
Singapore 486073
Republic of Singapore

In the Pacific:
Honeywell Pty Ltd.
5 Thomas Holt Drive
North Ryde NSW Australia 2113
(61 2) 9353 7000

In Japan:
Honeywell K.K.
14-6 Shibaura 1-chrome
Minato-ku, Tokyo, Japan 105-0023

Or, visit Honeywell on the World Wide Web at:
<http://www.honeywell.com>
Specifications are subject to change without notice.

For More Information

Learn more about how Honeywell's Hybrid Control Solutions can save you time, simplify maintenance and improve your control performance, visit our Website www.honeywell.com/ps or contact your Honeywell account manager.

Automation & Control Solutions

Process Solutions

Honeywell

2500 W. Union Hills Dr.

Phoenix, AZ 85027

Tel: 877.466.3993 or 602.313.6665

www.honeywell.com/ps

51-52-03-46
April 2009
© 2009 Honeywell International Inc.

The Honeywell logo is displayed in a bold, red, sans-serif font.