



WHAT'S NEW...

New Design for VLT® 8052 - VLT® 8402
(50 to 400 HP 525-690 VAC)

- Expanded input voltage range
- Lower cost – optimized options program allows you to buy only what you need
- Easy retrofit – variety of enclosure configurations to satisfy diverse installation requirements
- High reliability – optimized design simplifies mounting and wiring along with an overall reduction in the number of components
- High quality – manufactured in a state-of-the-art facility, utilizing the latest manufacturing processes with extensive testing and burn-in on every unit
- Increased performance – higher ambient temperature, improved EMC performance and higher dynamic brake duty cycle
- Easy maintenance and service – the drives are designed with high focus on maintenance and service to ensure continuous operation



VLT® 8000 AQUA Series Updates 7.01.05

VLT® 8000 AQUA Overview



VLT 8000 AQUA drives are available in chassis, NEMA 1 or NEMA 12 enclosures; 230 VAC input (5 to 60 HP), 380-480 VAC (5 to 600 HP) or 550-600 VAC (1.5 to 40 HP), or 525-690 VAC (50-400 HP) for CT/VT applications.

VLT® 8000 AQUA Benefits for Water and Wastewater Applications

- Provides and optimizes process control of flow, level and pressure
- Enables use of standard pumps with integral AC motors and can be installed into existing plants using standard AC motors
- Programmable for constant or variable torque operation: constant torque operation for maximum motor torque throughout speed range; variable torque operation optimized for maximum efficiency
- Ideal for controlling multiple parallel-coupled pumps/blowers
- Eliminates control valves and problematic pressure storage tanks
- Harmonic distortion protection built in
- Lower energy consumption
- Less pump noise
- Easy to set up and operate
- Comprehensive protection of drive, motor and process equipment
- Reduced maintenance
- Eliminates current in-rushes on the AC line
- No motor derating required
- Designed to communicate with programmable logic controllers as well as machine operators
- Resistant to extreme voltage and temperature conditions

- 5 to 60 HP, 200-240 VAC
- 5 to 600 HP, 380-480 VAC
- 1.5 to 40 HP, 550-600 VAC
- 50 to 400 HP, 525-690 VAC

VLT® 8000 AQUA Feature Highlights

Optimized Enclosures

- Ideal for panels
- Side by side flush mounting requires less panel space
- Optimized NEMA 12 enclosures offer stand-alone protection

Designed for Performance

- 1-600 HP constant or variable torque (CT/VT) operation
- Constant torque start and 160% breakaway current for up to 0.5 seconds for high torque loads
- 110% overload (CT/VT)
- Standard protection features include: phase-to-phase short; phase-to-ground short; input and output protection
- Unlimited switching on the drive output to the motor
- Fast response time for control inputs
- Built-in DC link inductors reduce harmonics

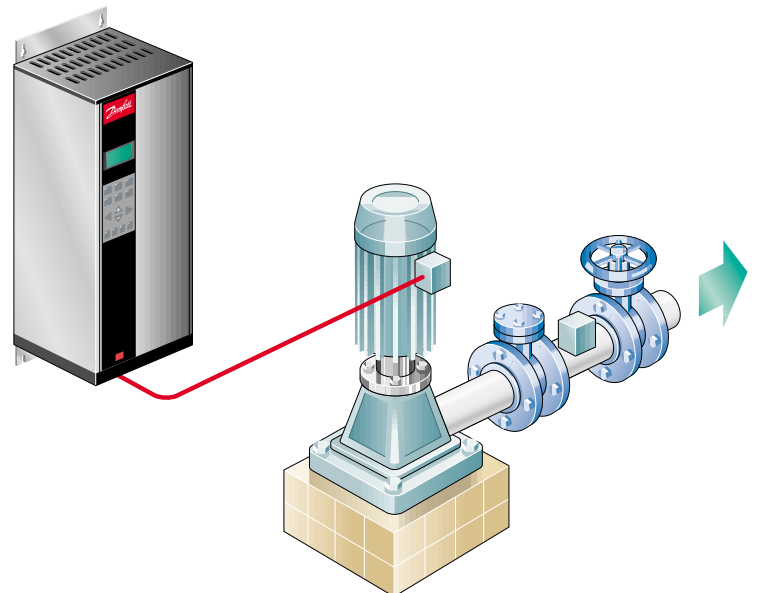

VLT® 8000 AQUA Overview

Enhanced Software

- Quick Menu has 12 primary parameters for quick start-up
- Electronic Thermal Relay provides motor overload protection
- Built-in two setpoint and two feedback PID controller
- AMA (Automatic Motor Adaptation) saves setup time by making most adjustments itself; optimizes operation between the drive and the motor— without the need to disconnect the motor from the load or spinning the motor
- Autoramping extends ramp up and ramp down time to prevent nuisance tripping
- Initial Ramp fill mode provides initial ramp feature to get pump running – optimized for the operation of submersible pumps
- AEO (Automatic Energy Optimizer) reduces energy consumption and audible motor noise
- Sleep mode automatically stops and starts the drive as determined by user-programmed levels at low demand— saves additional energy and reduces wear on drive components
- Run permissive logic circuit ensures system security prior to operation
- Dual pump/motor alternation

Versatile Interfaces

- Programmable I/O selector switches, pushbuttons and indicator lights for manual devices
- Built-in H-O-A (Hand-Off-Auto) switch function on keypad
- Direct thermistor input for motor thermal protection
- Alarm, Warning and On LEDs indicate drive status
- Built-in RS-485 is fully-equipped for serial communication – up to 31 drives can be connected to one serial bus
- Window-based programming, system monitoring control or diagnostics with VLT Dialog software
- Galvanically-isolated I/O

International Approvals

- UL
- cUL
- CE (230, 460 and 690 V units)



VLT® 8000 AQUA

A

Engineered Panel Solutions

(See Section E for complete information)

The Engineered Panel Solutions program for the VLT 8000 AQUA family provides increased functionality. These enclosures are available in NEMA 1, 3R, 4/4X, 12 and offer a variety of control configurations.

Options (Factory built-in) (Pages A 38-42)

Enclosures

- Chassis (IP00)
- Protected Chassis (IP20)
- NEMA 1 (IP20)
- NEMA 12 (IP54)

Hardware

- Standard
- Extended with Drive Disconnect

RFI Filter

- Class 1 Group A

Fieldbus Options

- Profibus DP/FMS
- Modbus RTU
- DeviceNet

Application Options

- 4-Relay option card
- Cascade Controller

Conformal Coating

Accessories (See Section F)

- Remote keypad kit
- EMC/RFI filters
- LC filters
- Line Reactors
- Harmonic traps
- VLT Dialog Software

Keypad and Display Functions



Fast, Simple, Automatic Start-Up

The VLT 8000 AQUA has a two level menu-prompted software structure. The first level, referred to as the Quick Set-Up Menu, contains the twelve most commonly used parameters; the second level offers extended programming capabilities. If the drive and the motor are of the same rated size, programming is not normally necessary – simply connect the AC line, the motor and the control wires, and start the VLT 8000 AQUA.

Versatile Data Display

The VLT 8000 AQUA drive's four line, alphanumeric, backlit LCD display is easy to read from any angle. With three lines of 20 characters and one line of eight double-sized characters. Up to four measurements can be shown continuously on the top two lines of the display. Choose from twenty-five different items to display, including input reference, motor current, hours run, and output frequency, horsepower, kW or kWh, or select from custom units, such as GPM or HP.

H-O-A Manual or Automatic Control

The VLT 8000 AQUA's keypad separates the H-O-A (Hand-Off-Auto) functions for easy, logical control of the drive. Local control is easily accomplished by simply pressing the HAND START key and controlling the drive's speed using the + and - keys. Activating the Remote/Auto button enables remote operation via the control terminals.

Keypad (LCP – Local Control Panel)

All VLT 8000 AQUA drives use the same control panel, menu-driven operating system and cabling connections. Once familiar with one drive, an operator can start-up, program and operate any other drive throughout the HP range.

- Interchangeable LCP keypad contains non-volatile memory for uploading/downloading parameters for single and multiple drive installations.
- LCP keypad may be removed for secure, tamper-proof operation. (The drive's status lights operate independent of keypad). The operational status on the drive include a green "ON", yellow "WARNING", and red "ALARM" LEDs.
- The VLT 8000 AQUA's LCP keypad can be remotely mounted up to 10 feet by using one of the optional NEMA 1 or NEMA 12 remote mounting kits (ideal for panel mounting).

Quick Set-Up Menu

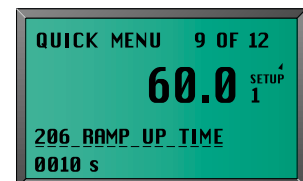
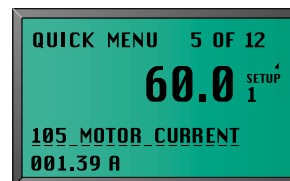
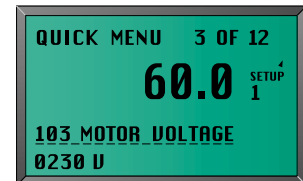
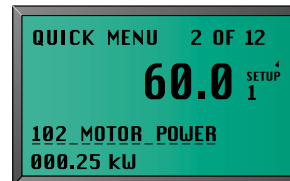

With the direct-access Quick Menu, most installations are commissioned by simply scrolling through the twelve parameter settings to confirm that they match your requirements. Once checked, the values set are automatically stored in non-volatile memory. That's it! After setting up one drive, the removable Keypad/Display can be used to transfer the same settings to all other VLT 8000 AQUA drives.

Quick Set-up Menu items include:











- Language select
- Motor horsepower
- Motor voltage
- Motor frequency
- Motor current
- Motor rated speed
- Low limit output frequency
- High limit output frequency
- Ramp up time
- Ramp down time
- Relay 1 output
- Relay 2 output

Keypad and Display Functions

Control Keys

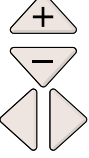
The control keys on the LCP are divided into functions. The keys between the LCD display and the LEDs are used for parameter setup, including choice of display indication during normal operation.

Keys for local control are found under the LEDs.

	[DISPLAY MODE] is used for selecting the mode of display or for changing back to Display mode from either the Quick menu mode or the Menu mode.
	[QUICK MENU] is used for programming the VLT unit using the 12 parameters in the Quick menu. It is possible to switch directly between Quick menu mode and Menu mode.
	[EXTENDED MENU] provides the access to all parameters for programming. It is possible to switch directly between Menu mode and Quick menu mode.
	[CHANGE DATA] is used for changing the data value of a parameter when programming.
	[CANCEL] is used to cancel the last programming command so it is not carried out.
	[OK] is used for confirming that the last programming change is acceptable and should be stored.
	[+/-], [<>] provide the user the ability to move the cursor around the LCD display, or sequence through display values. These keys are active during operation as well as programming modes.
	[HAND START] is used to start the motor. When Hand Start is activated, signals including Off Stop, Auto Start, Reset, Safety Interlock, Coasting Stop Inverse, Reversing, Setup Select, Jog, Run Permissive, Lock for Data Change, Stop Command from Serial Communication remain active.
	[OFF STOP] stops the motor.
	[AUTO START] is used if the VLT is to be controlled via the control terminals and/or serial communication. When a start signal is active on the control terminals and/or the bus, the VLT will start.
	[RESET] is used for resetting the VLT after an alarm (trip).

Operating variable

Operating variable	Unit
Reference	[%]
Reference	[unit]
Frequency	[Hz]
% max. output frequency	[%]
Motor current	[A]
Power	[kW]
Power	[HP]
Output energy	[kWh]
Motor voltage	[V]
DC-link voltage	[V]
Motor thermal load	[%]
VLT thermal load	[%]
Hours run	[hours]
Input status, digital input	[binary code]
Input status, analog terminal 53	[V]
Input status, analog terminal 54	[V]
Input status, analog terminal 60	[mA]
Pulse reference	[Hz]
External reference	[%]
Cooling plate temperature	[°C]
User-defined readout	[unit]
Setpoint 1	[unit]
Setpoint 2	[unit]
Feedback	[unit]
Feedback 1	[unit]
Feedback 2	[unit]
User-defined text	[-]

Functionality to Increase Efficiency

Operating Characteristics

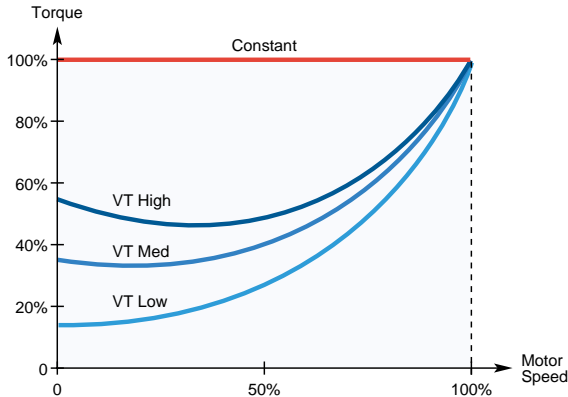

Choice of Torque Modes

The VLT 8000 AQUA can be programmed for efficient operation in Constant Torque or Variable Torque applications.

Constant Torque operation demands that the motor have the ability to produce a constant and consistent amount of torque on its shaft while operating throughout the rated speed range. When the VLT 8000 AQUA is programmed for operation in Constant Torque mode a load-dependant U/f characteristic is obtained in which output voltage and frequency increase with increasing loads to maintain constant energy to the motor.

Typical Constant Torque applications where the torque requirements remain constant throughout the operational speed range are; conveyors, cranes and positive displacement pumps/fans/blowers.

Variable Torque loads create a non-linear relationship between the speed and torque on a motor's shaft. Typically the load increases at the square of the increase in speed; for example if the speed increases by 25% the resulting load on the shaft would increase approximately 50%.

Installations operating under Variable Torque conditions typically involve control of fans or centrifugal pumps. Differences in equipment and applications can result in the variations in the speed-torque curve profile. Matching an adjustable frequency drive's output (U/f ratio) to the speed-torque curve as closely as possible results in improved energy efficiency and overall process control.

The VLT 8000 AQUA Series drive offers the ability to choose between three (3) Variable Torque curve profiles to closely match your application's requirements. Selecting the closest operating curve between the VT High, VT Medium and VT Low will provide the maximum energy efficiency in the application.

Constant Torque Start, Breakaway Current for High Torque Loads

Even when operating in variable torque mode, the VLT 8000 AQUA assumes a constant torque mode of operation during start. This assures that the load accelerates to the commanded speed. Breakaway torque provides up to 160% of rated current for up to 0.5 seconds to ensure that sufficient torque is produced to begin operation.

Specialized Software Functionality

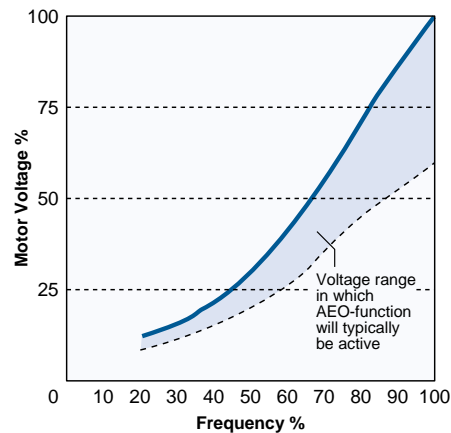

AEO (Automatic Energy Optimization)

- Increased energy savings
- Extends motor life by reducing heat of the motor
- Minimizes audible noise in the motor
- Maintains high system efficiency, even in applications using oversized motors

AEO is a unique control scheme that ensures an optimum relationship between voltage and frequency depending on the actual load. Most PWM drive control schemes allow changes in the V/Hz ratio, but the response is based on an expected load (not actual) at various frequencies. In other words, conventional PWM drives estimate the torque required based on the output frequency and a predetermined torque profile, not on the actual torque requirement. As a result, energy is lost as heat in the motor. Utilizing the AEO function, the VLT 8000 AQUA provides up to 5% energy savings in comparison to other PWM drives.

Functionality to Increase Efficiency

Sleep Mode with Torque Boost

Sleep Mode monitors the input signal determining the output frequency of the VLT 8000 AQUA, and thus, the system's flow/pressure. When the signal has decreased to the point that the output frequency (motor's speed), has become inefficient and the resulting flow/pressure is negligible, Sleep Mode automatically turns the output off to save energy. Once the unit senses that the system has reached a point where the motor-driven pump will be effective, Sleep Mode "wakes up" the VLT 8000 AQUA and operation resumes.

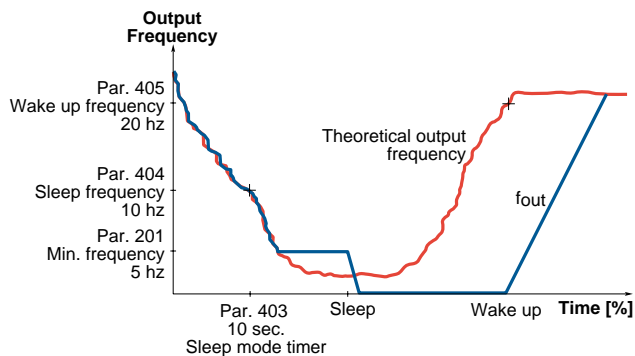

Pump/Motor Alternation

The VLT 8000 AQUA includes a built-in software function to provide an automatic means to alternate between two pump/motors. The pump/motor alternation feature provides a 0.1 to 999 hour crossover between two pump/motors, eliminating the need for an external pump controller and decreases wear and maintenance requirements. A built-in relay is used to signal the motor contactors (customer supplied) to alternate motor operation.

Run Permissive Circuit

This circuit accepts a "system ready" signal to ensure that peripheral equipment is in the proper state before a start command commences drive operation.

Built-in Two Setpoint and Two Feedback PID Controller

The integral, digital PID (Proportional Integral Derivative) control eliminates overcompensation and the need for an additional external regulator, including a low-pass filter. The PID can monitor two feedback signals, compare the two setpoints and make various process control decisions.

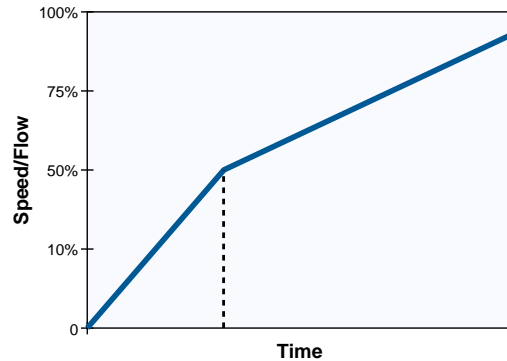

Initial Ramp/Empty Pipe Fill Mode

Submersible pumps and other equipment often have a requirement to not operate below a minimum speed any longer than necessary to avoid damage and excessive wear. The initial ramp is used to quickly accelerate the motor/equipment to a minimum speed at which point the normal ramp up rate is activated.

The VLT 8000 AQUA also provides a unique empty pipe fill mode function whereby the drive will operate the pump at a specified rate for a preset time, then automatically follow the PID. The function is typically used for dry start-ups to quickly fill a plumbing system without causing a "water hammer" effect that often occurs under such conditions. Both acceleration rates and times are fully programmable to suit any application.

Autoramping

The autoramping function extends ramp up and ramp down time, dependent on load requirements, to prevent nuisance tripping. Autoramping will automatically modify a typical fixed acceleration/deceleration rate and adjust it to suit the system requirements.

AMA (Automatic Motor Adaptation)

The AMA function provides an automatic means to "tune" the VLT 8000 AQUA to its connected motor. AMA automatically optimizes operation between the drive and the motor by reading and checking the values without spinning the motor, so there's no wasted time disconnecting the motor from the load.

Built-in Protection



VLT® 8000 AQUA has Built-in Protection to Maximize System Reliability

- System overloads
- Motor failures
- Motor and drive overheating
- Voltage disturbances
- Power surges
- Loss of phase
- Phase-to-phase and phase-to-ground short circuit
- Ground fault
- Switching on input/output
- Electrical disturbances
- Triple layer galvanic isolation
- Self-testing
- Overvoltage
- Over-current
- Under-voltage
- External fault
- ETR (Electronic Thermal Relay)

Input Line Protection from Extreme Running Conditions

Line Disturbances and Transients

To protect itself from AC line voltage disturbances, the drive monitors all three phases and interrupts drive operation for phase loss or if there is phase imbalance. Transients on the AC line are suppressed by MOV's as well as zener diodes for extreme transients. Danfoss VLT 8000 AQUA drives meet VDE 0160 (European standard – 2.3 x line voltage for 1.3 msec) for transient protection.

Voltage Sags and Surges

The VLT 8000 AQUA is designed for a wide range of operating conditions. The 480 volt drive will operate from 342-528 VAC. The 230 volt drives will operate on 180-264 VAC. 575 volt drives will operate on 495-660 VAC and 690 volt drives will operate on 472-759 VAC. Full rated motor voltage and torque can be delivered down to 10% under nominal AC line voltage. During an AC line drop-out, the VLT 8000 AQUA continues until the intermediate circuit voltage drops below the minimum stop level, which is typically 15% below the VLT 8000 AQUA's lowest rated supply voltage.

Short Circuit

The VLT 8000 AQUA is protected against short circuits by means of current measurement in each of the three motor phases. A short circuit between two output phases will shut down the inverter as soon as the current exceeds the permitted value.

Ground Fault

The VLT 8000 AQUA provides complete protection from potentially damaging ground fault conditions:

- On the supply side
- On the motor side

Optimally Low Motor Noise Through ASFM

With the ASFM (Adjustable Switching Frequency Modulation) function, the switching frequency is adjusted automatically in relation to the speed of the motor. As speed is reduced, the switching frequency increases to ensure optimally low motor noise.

Built-in Protection

VVC^{PLUS} Output Switching Pattern

Unique digital VVC^{PLUS} voltage vector control provides:

- Nearly perfect output sine wave reduces over and undershooting of voltage and current as generated by standard PWM drives
- Fully rated motor voltage at rated frequency
- High efficiency for both drive and motor
- Full motor performance without derating; no additional heating of motor windings

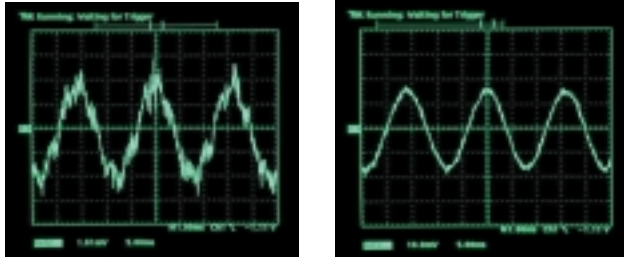

PWM scope trace (left) compared to smoother VVC^{PLUS} scope trace (right).

Exclusive “Soft Turn On” IGBT Technology

With the patented Danfoss “soft turn on”, the IGBT transistors produce one of the lowest dV/dt in the industry.

- Motor cable lengths up to 1,000 feet standard
- Motor output reactors built in as standard on all drives 100 HP and larger
- Unlimited switching on the output

Minimal Harmonic Distortion/Maximum Power Factor

The DC link inductor reduces the harmonic distortion currents that an adjustable frequency drive injects back into the AC line. A properly sized inductor, such as that in a VLT 8000 AQUA can reduce line harmonic currents to 40% or less of the fundamental current. This eliminates the need and cost of additional AC line reactors and their resultant line voltage reduction.

Reduced Installation Cost

The dual DC link inductors reduce the input RMS current to be less than or equal to the output current. This greatly reduces the cable size requirement and the subsequent cost of installation.

Output Protection

VLT 8000 AQUA drives incorporate both DC link inductors and motor output protection as standard design features. This provides short circuit protection and allows unlimited switching on the output without damage to the drive, eliminating the need for additional output reactors or switch interlocks.

The DC link inductor improves overall efficiency by increasing the power factor and lowering the ripple current in the bus voltage for an almost threefold increase in capacitor and drive life. As a result, motor operation is smooth and quiet and longer motor life can be expected.

Hall effect current transducers measure current flowing on all three motor phases. This provides highly responsive and accurate feedback to the VLT control circuit for optimum motor protection and performance.

Thermal Protection for the Drive and Motor

The ETR (Electronic Thermal Relay) is an open loop method built into the VLT 8000 AQUA software to guard against motor overheating – requiring no additional sensors or wiring. This function is UL recognized (Class 20) as an effective guard against motor thermal overload.

The VLT 8000 AQUA has drive thermal protection and also accepts thermistor signal input from the motor to create closed loop thermal protection for the entire system.

Control Inputs and Outputs

Typical VLT® 8000 AQUA Wiring Connections

The illustration below shows how a VLT 8000 AQUA typically interfaces with other components in a system. The terminal numbers and functions are identical on all VLT 8000 AQUA drives. The analog, digital and relay terminals are all programmable. The functions shown here are typical, but show only a small portion of the total capability.

Control Card Benefits

The standard I/O supplied on the VLT 8000 AQUA drive is equal to or greater than that supplied by most competitive drives which feature extended I/O options.

Standard I/O includes:

- 8 digital inputs
- 3 analog inputs
- 2 analog/digital outputs
- 2 relay outputs

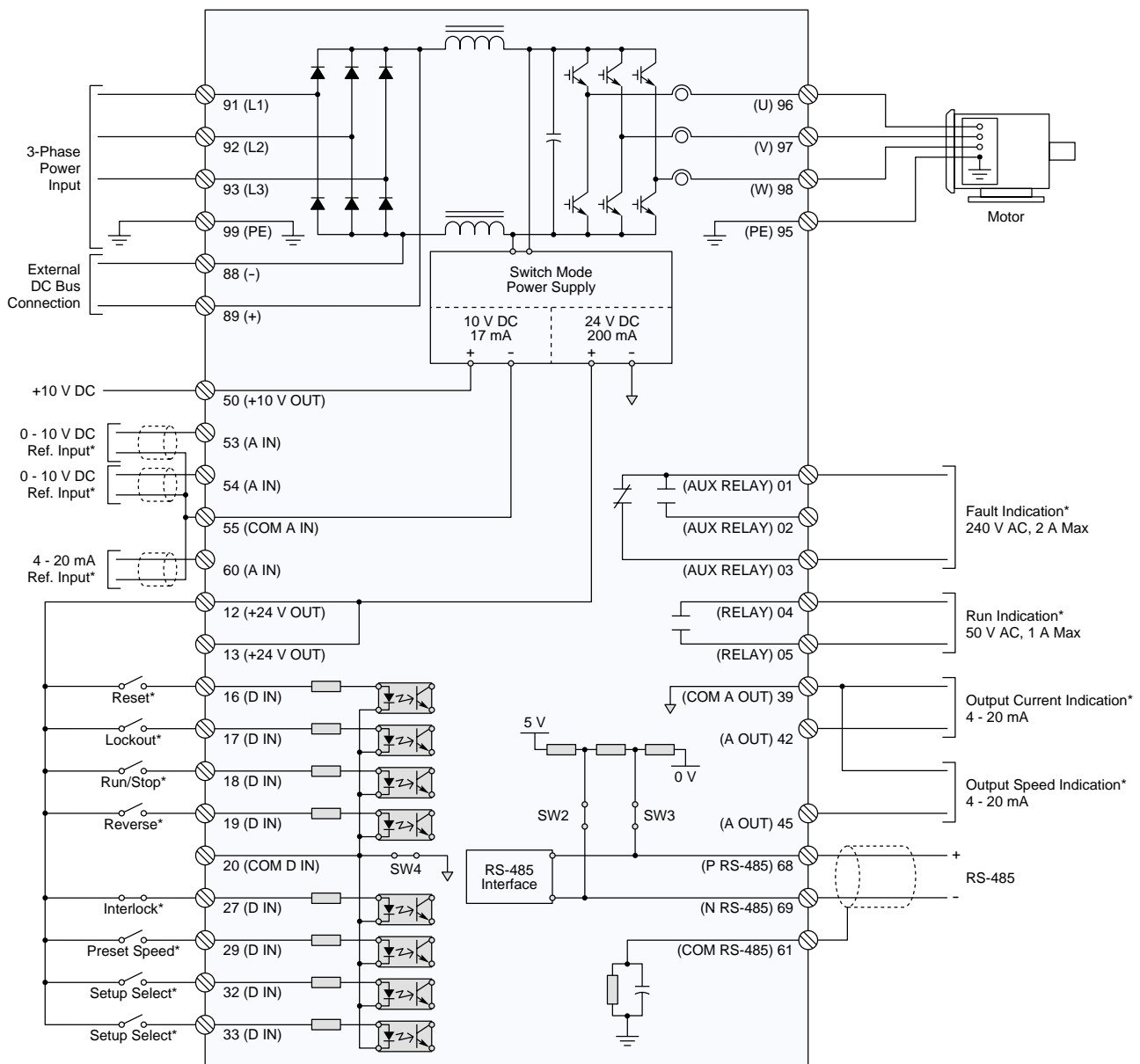

*The operation of all control inputs and outputs is programmable. Typical terminal functions are shown.

Control Inputs and Outputs

Isolation

All analog and digital inputs/outputs and the RS-485 serial communication port are galvanically isolated. Because these points do not share a common, the drive can eliminate ground loop problems. In the VLT 8000 AQUA Series, all control terminals, as well as terminals 1-5 (AUX relays), are supplied by or connected to circuits that comply with PELV (high impedance) requirements in relation to the AC line potential.

Digital Inputs

There are eight digital inputs that offer a wide range of programmability. Typical control functions such as Run/Stop, Jog, and Forward/Reverse commands; as well as more dedicated settings such as preset speeds, setup select, interlock, etc. are supported. All digital inputs operate on a nominal 24 VDC level so a wide range of input switching devices may be utilized.

Analog Inputs

Two analog inputs for voltage signals and one input for current signals are provided for reference and feedback signals. A thermistor can also be connected to either voltage input. The two analog voltage inputs can be scaled in the range of 0-10 VDC; the current input in the range of 0/4-20 mA.

Digital/Analog Outputs

The two digital/analog outputs can be programmed to show present drive status or a process value. When used as a digital output, the VLT 8000 AQUA presents status with a 0/4- 24 VDC signal. The drive supports two types of analog signals: 0/4-20 mA. The terminals can also be configured for voltage output (0-10V) with the addition of a pull-down resistor (recommended 500 ohm, 1W).

Relay Outputs

Relay outputs may be selected to indicate thirty different functions such as ready, run, trip, current above a customer preset value, current above current limit, frequency within customer preset limits, frequency above a customer preset value, electronic motor over temperature protection warning, or that remote operation mode has been selected.



VLT® 8000 AQUA

A